



# Nilfisk



128337176

Kornmarksvej 1|DK-2605 Broendby|Denmark|Tel.: (+45) 4323 8100

## Quick Start Guide - Excellent 160

**Caution:** Read the instructions before using the machine

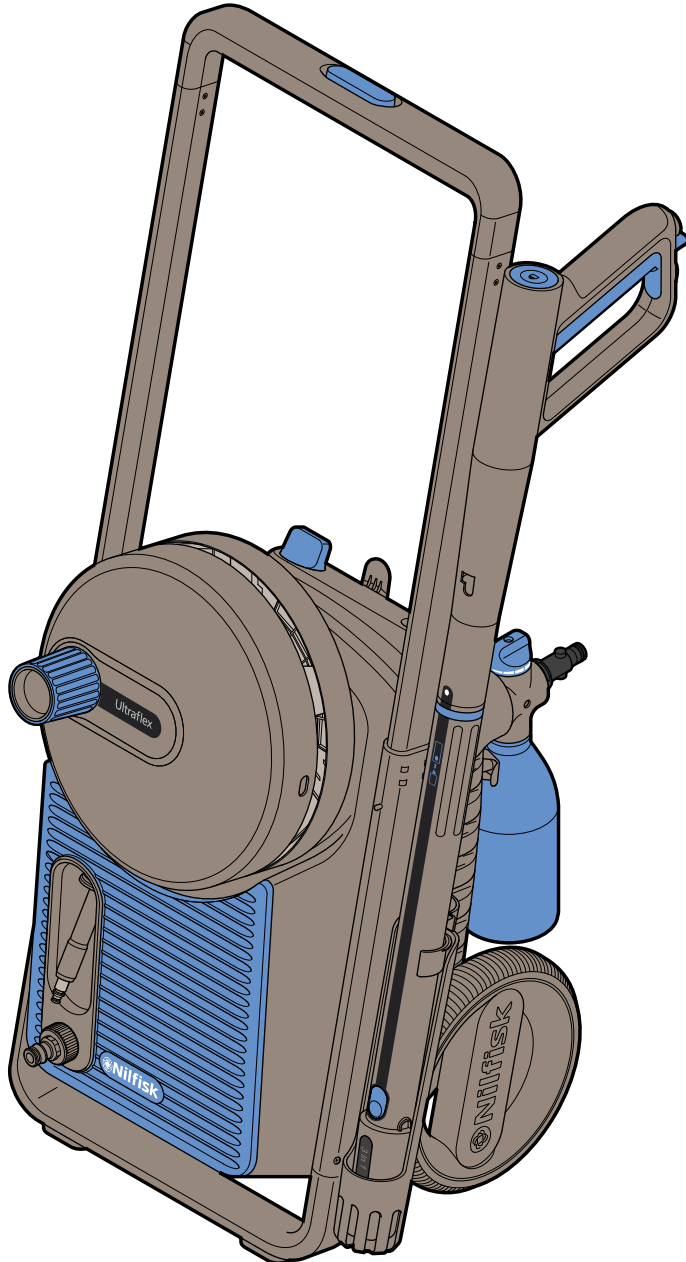

Excellent 160

A

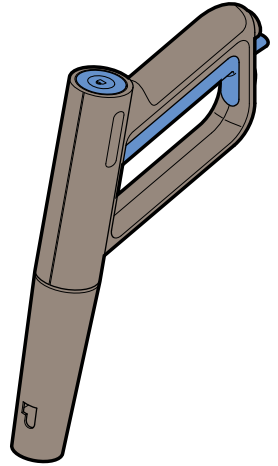
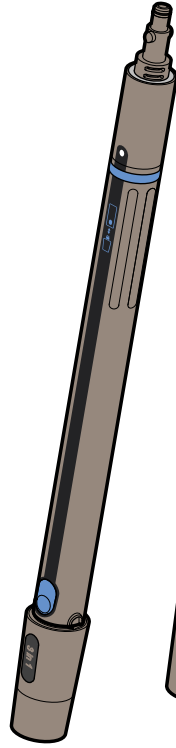

x2

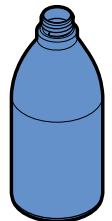
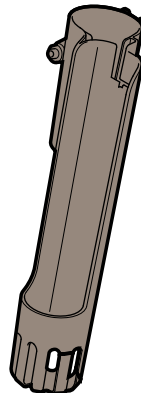
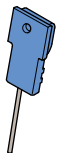
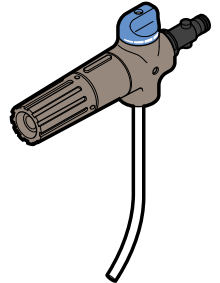

Excellent 160

A



1

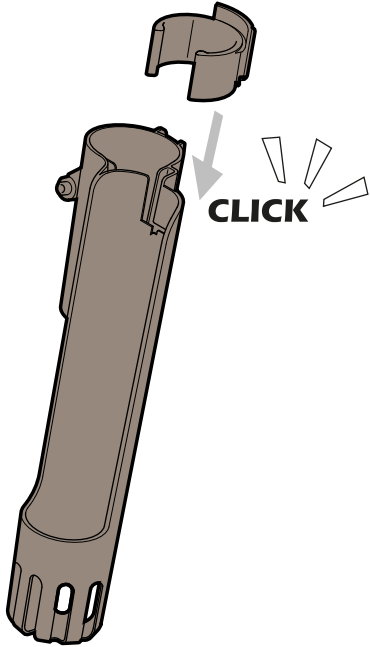

2

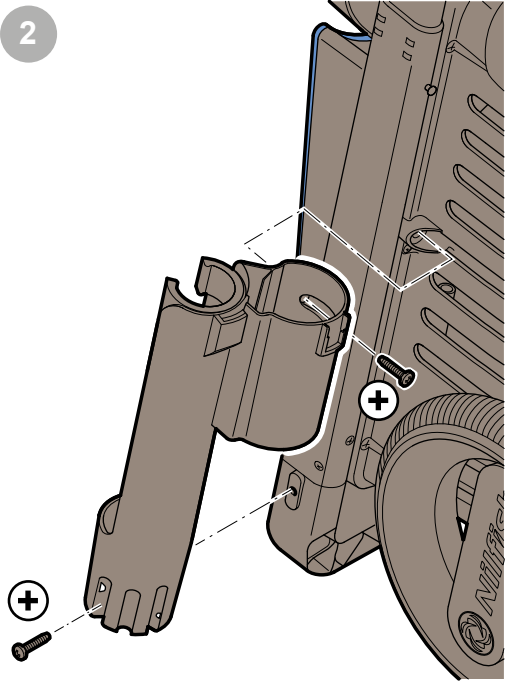

3

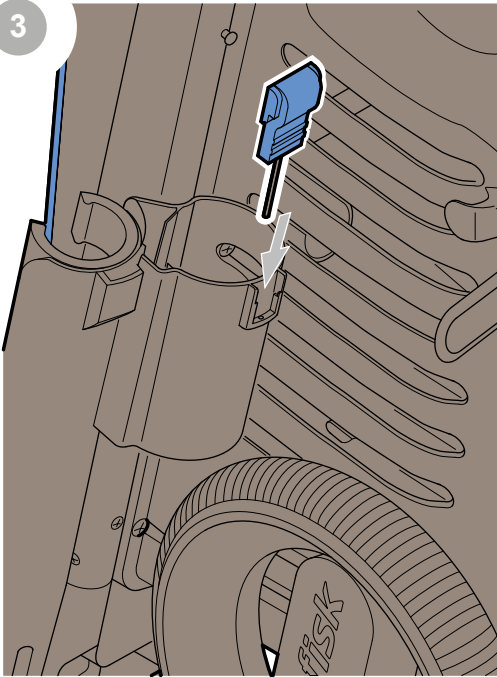

4

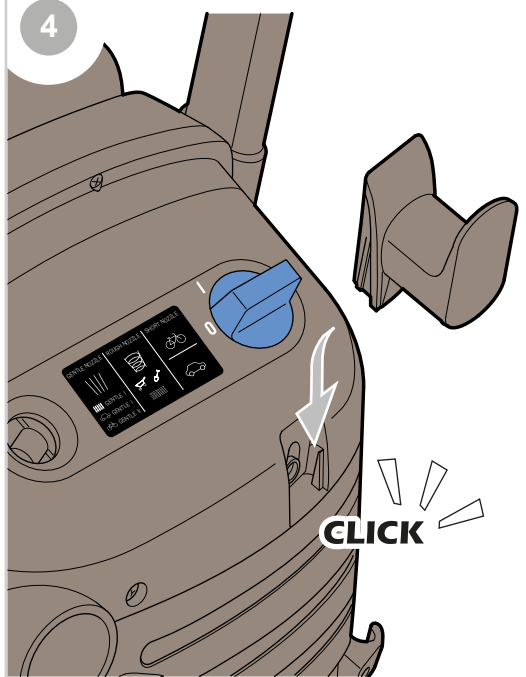

A



5

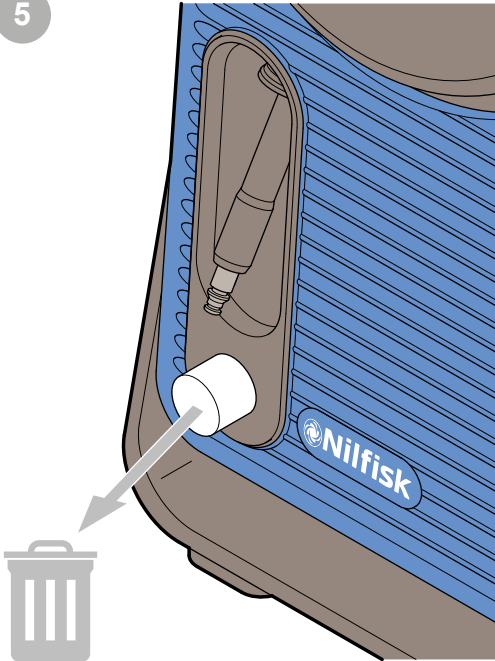

6

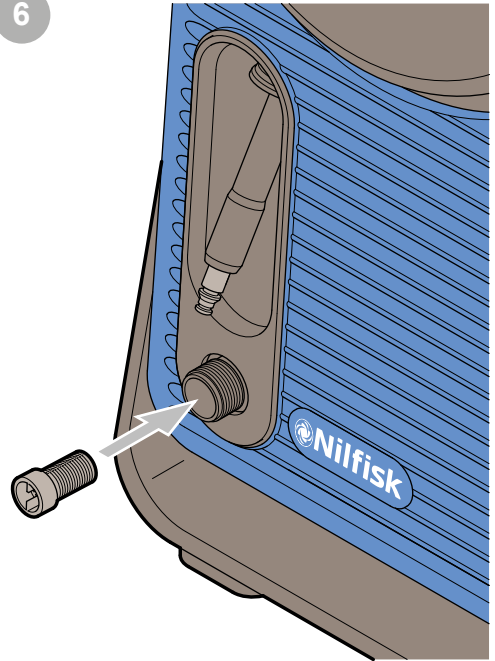

7

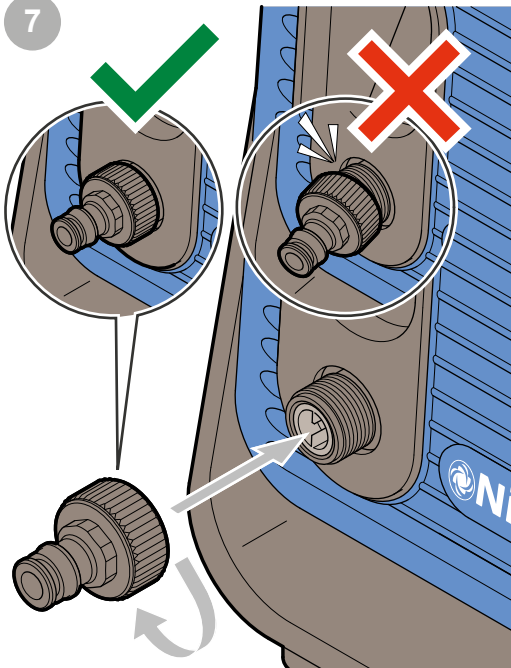

8

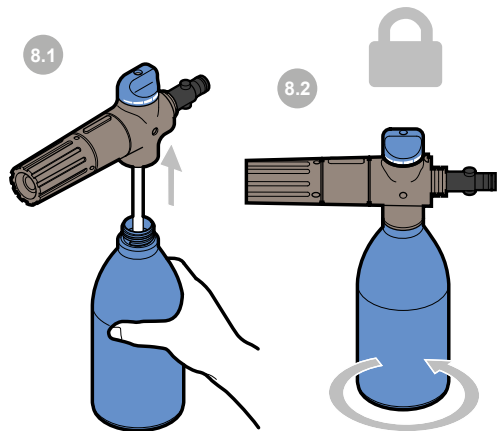

A

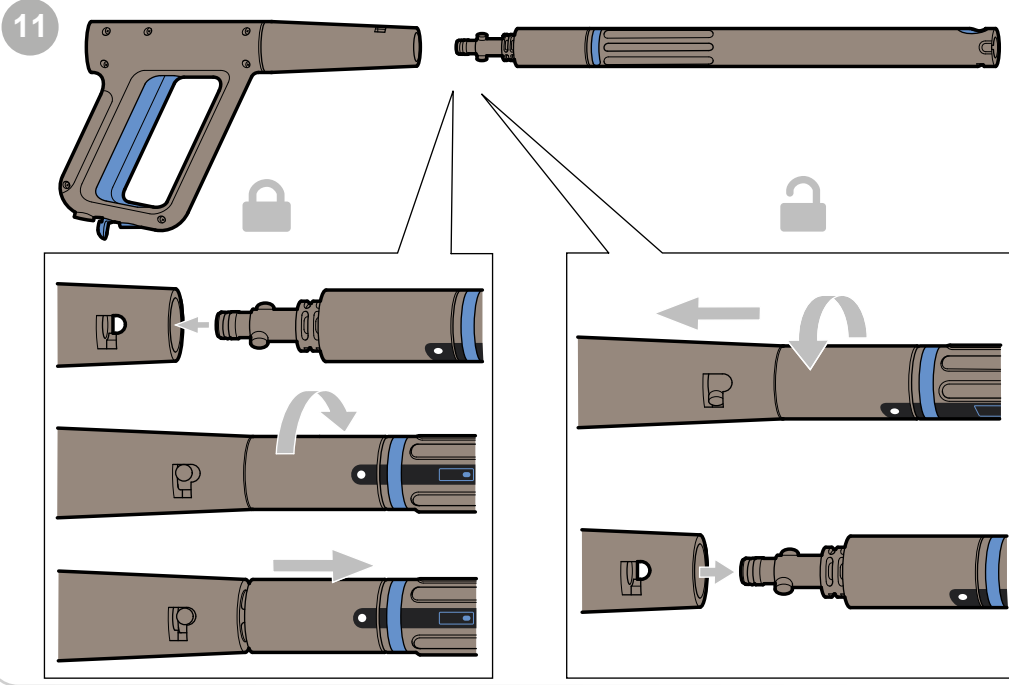
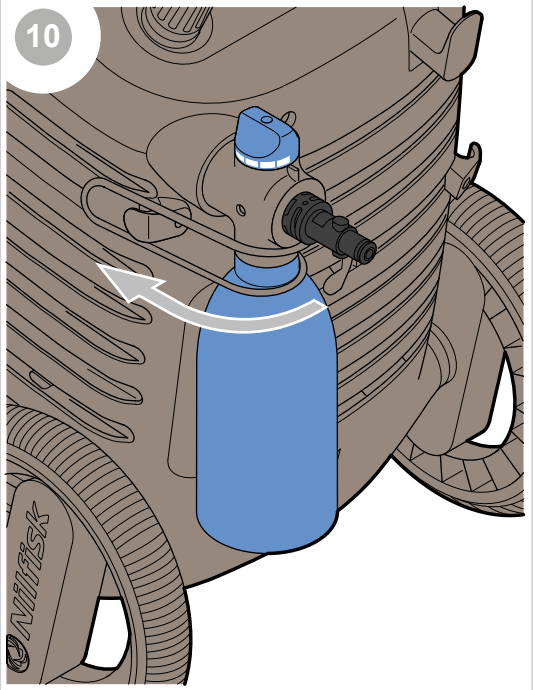
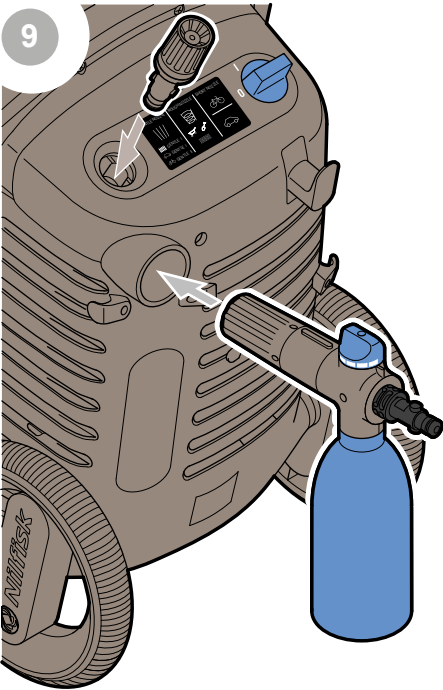

A



12

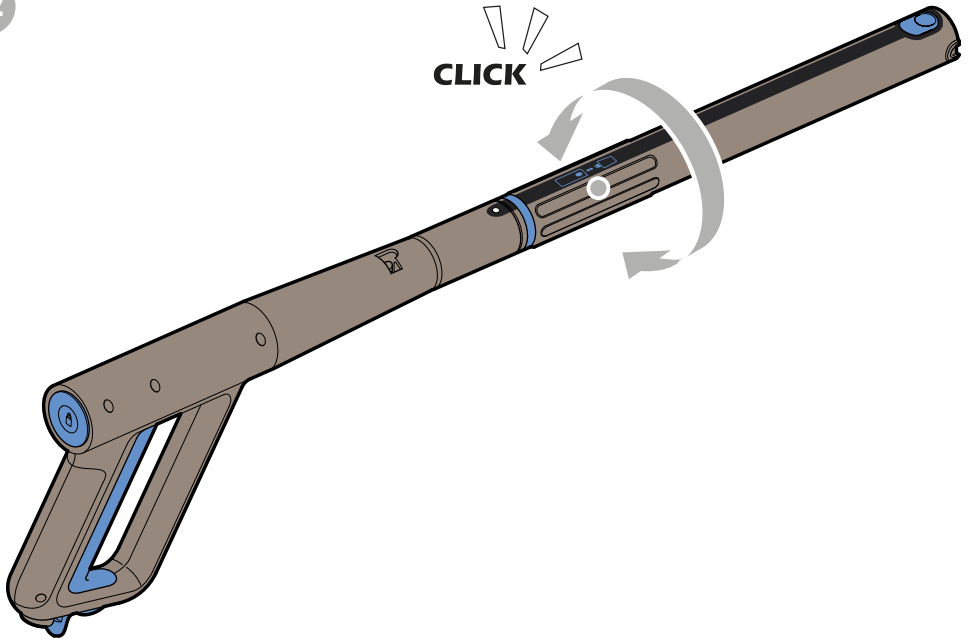

13

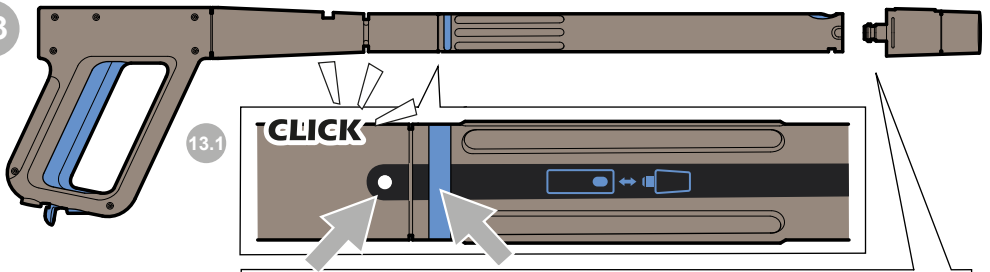

13.2

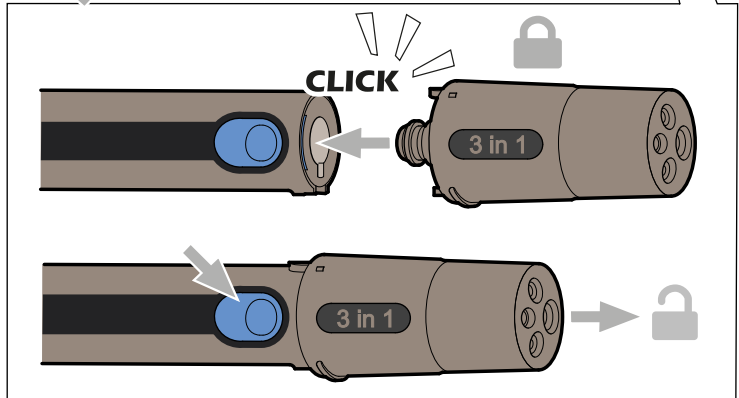

A



14

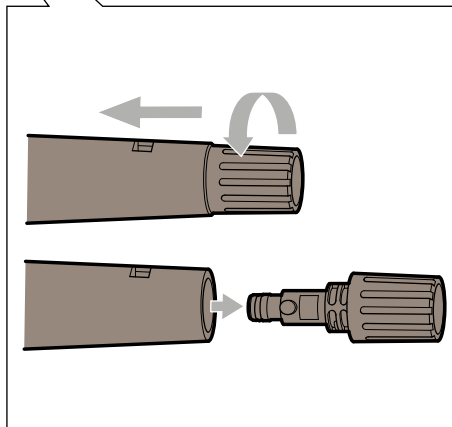
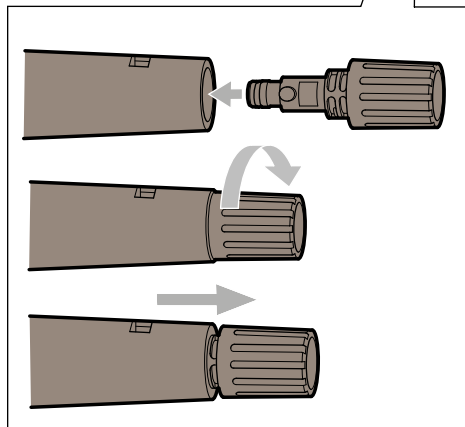
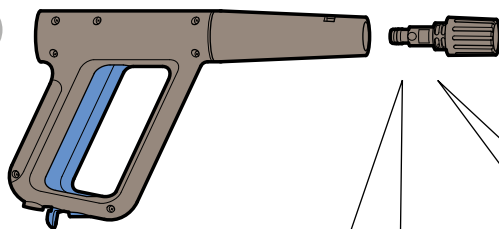

15

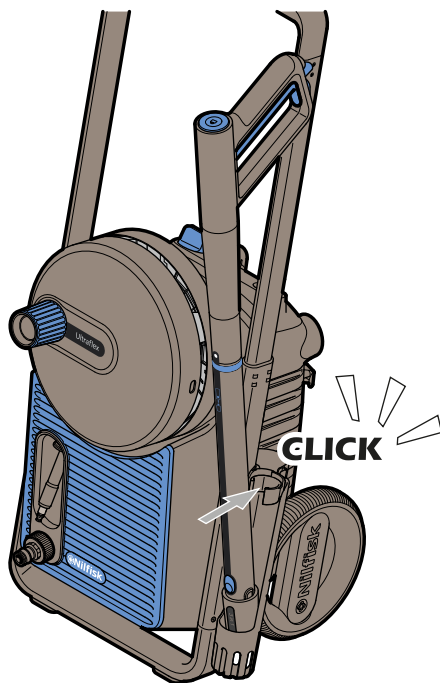

16

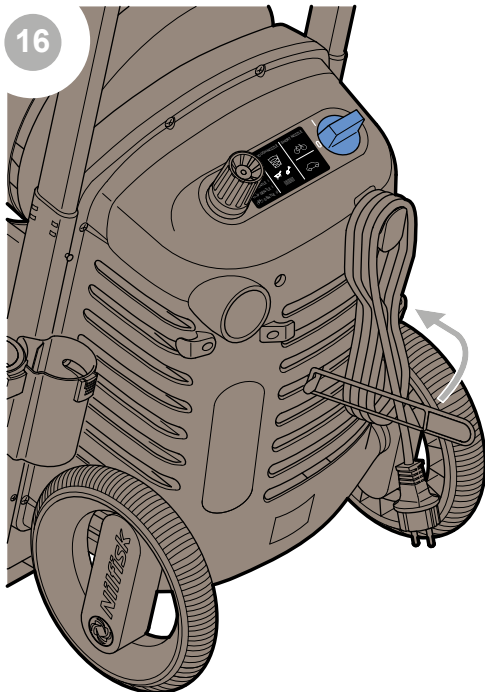

B



1

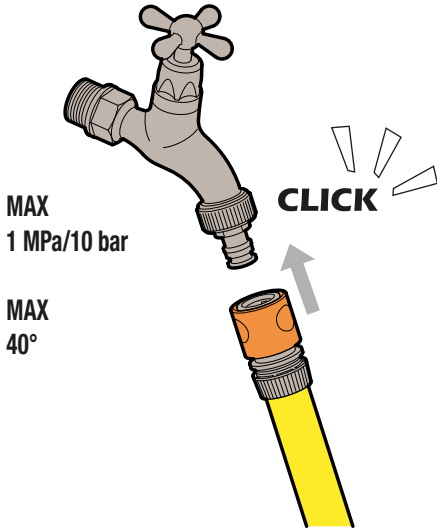

2

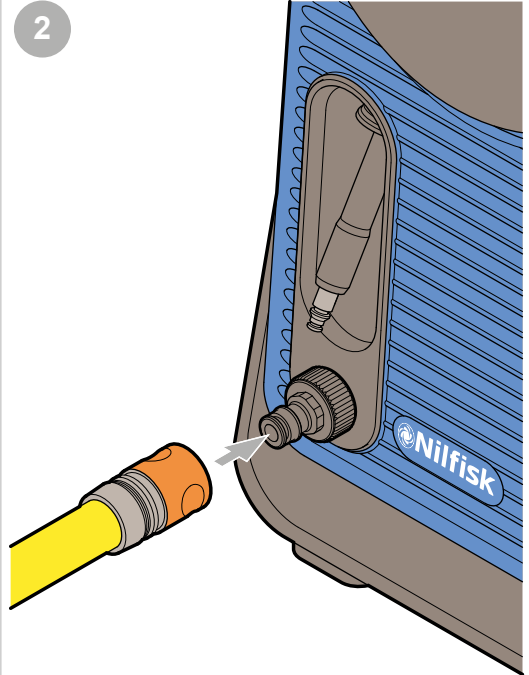

3

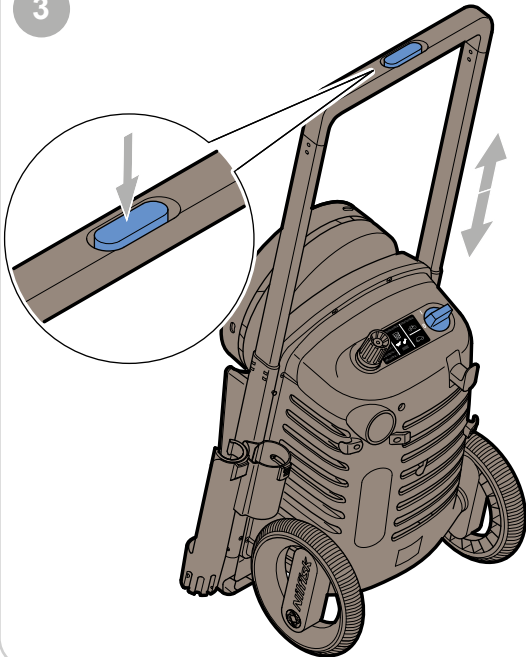

4

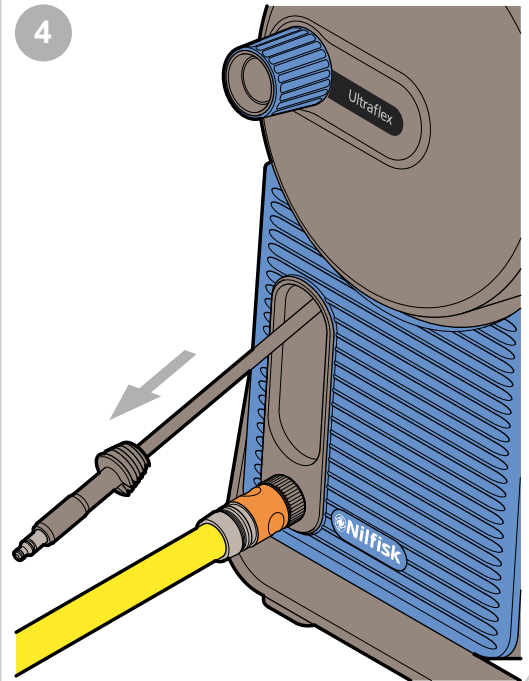



B



5

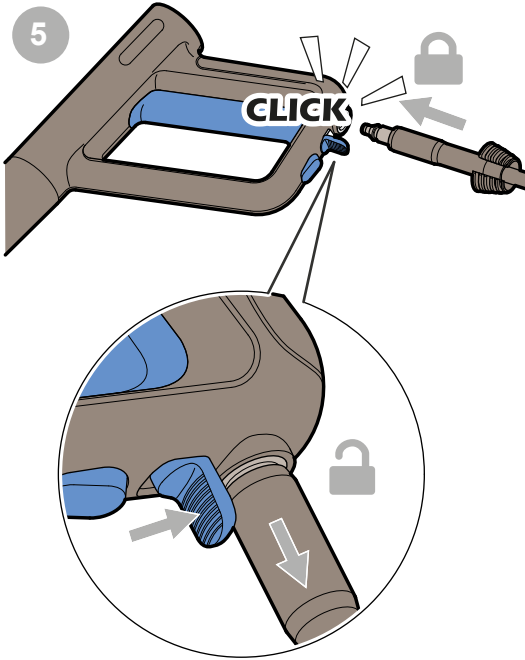

6

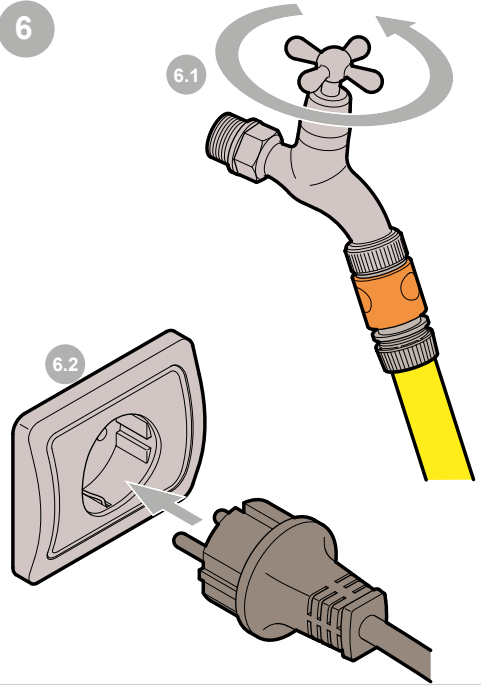

7

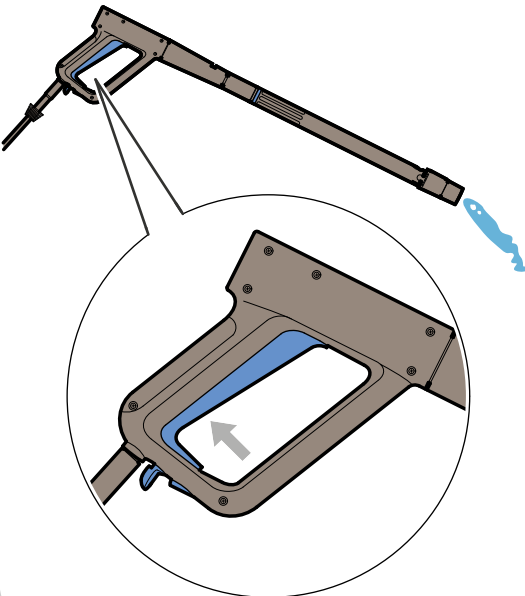

8

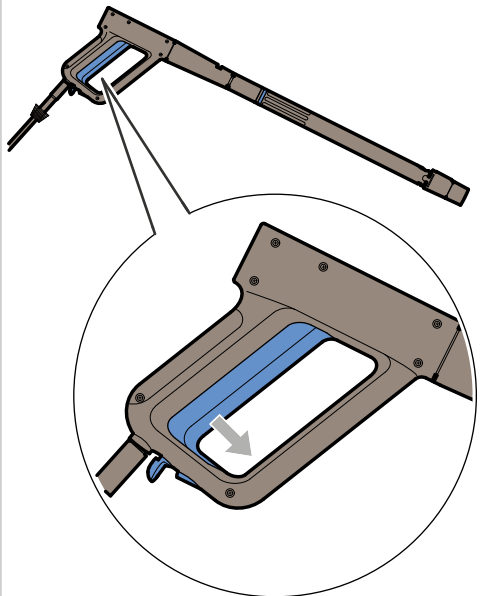

B



9

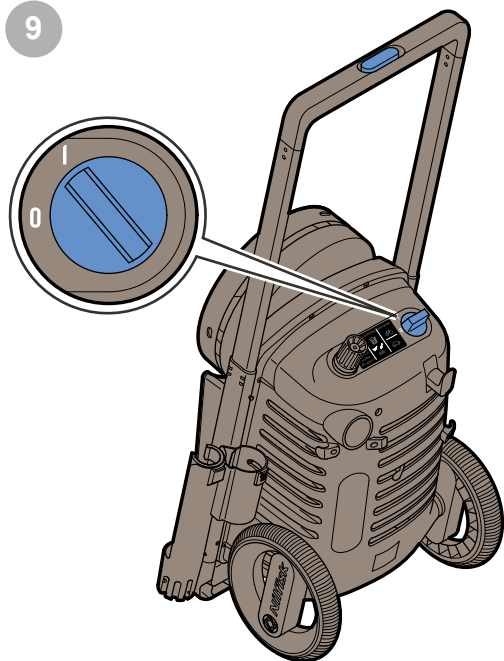

10

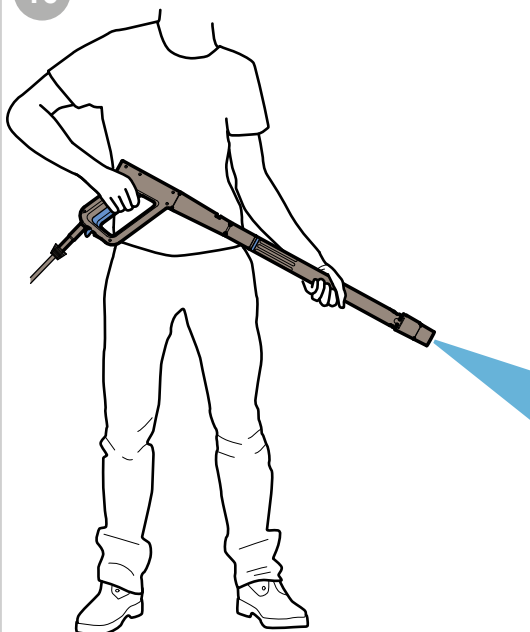

11

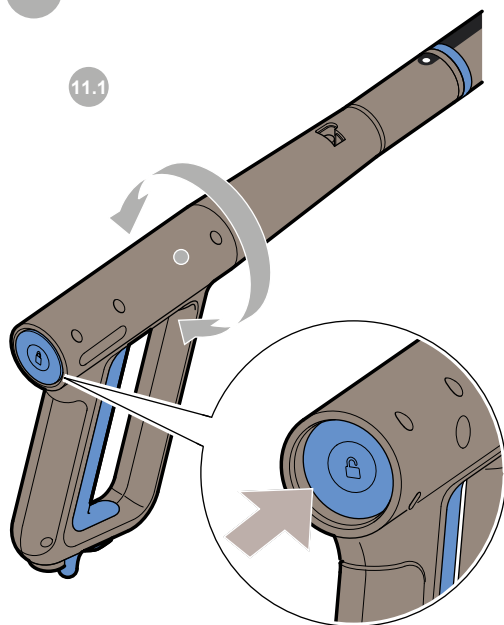

11.1

11.2

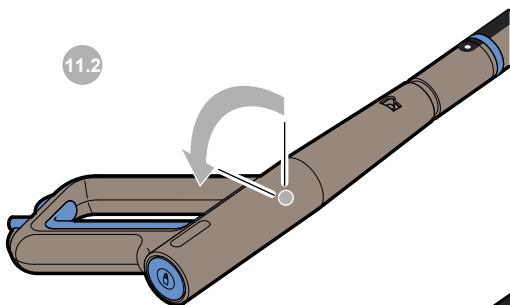

11.3

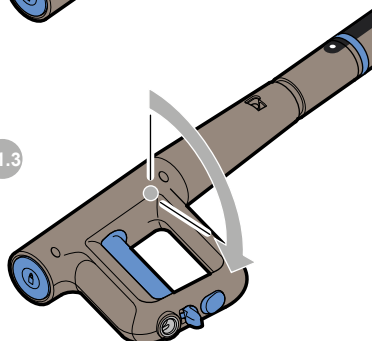

B



12



ROUGH NOZZLE

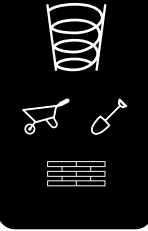

ROUGH

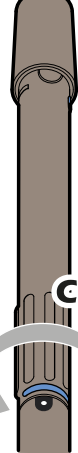

GENTLE 1

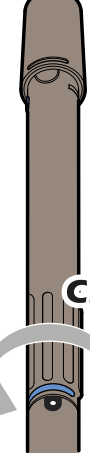

GENTLE 2

GENTLE NOZZLE

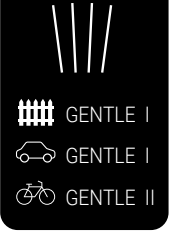

CLICK

CLICK

13

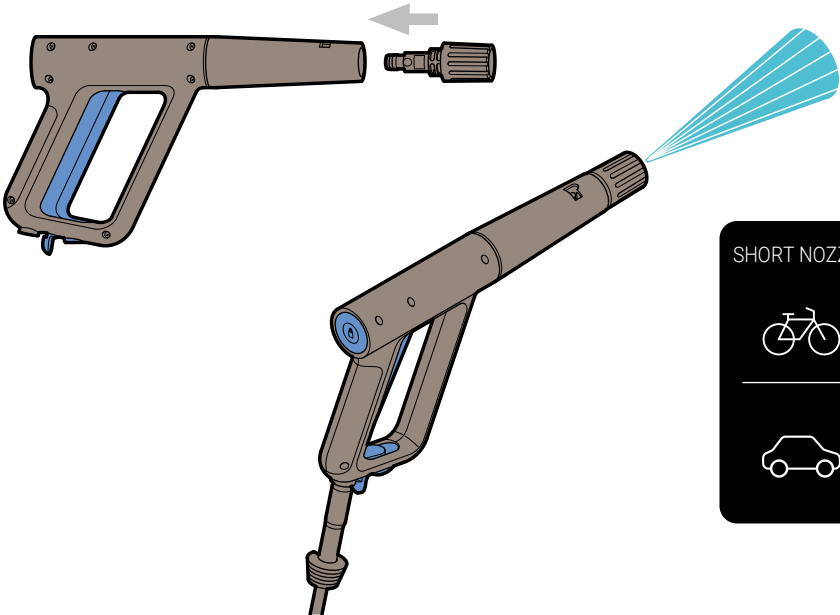

SHORT NOZZLE

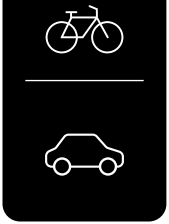

# B



14

14.1

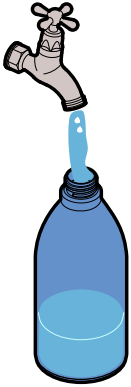

14.2

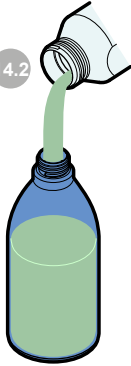

14.3

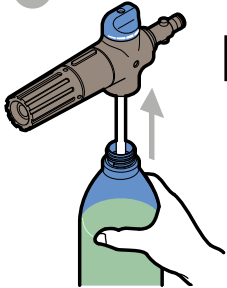

14.4

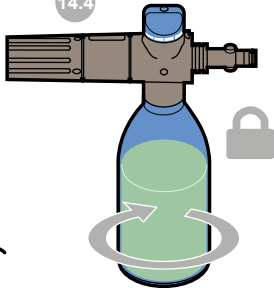

15

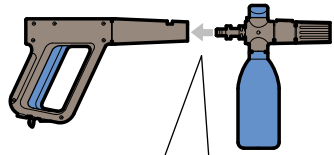

15.1

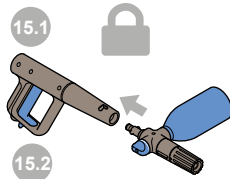

15.2

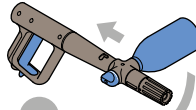

15.3

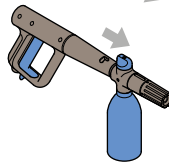

15.4

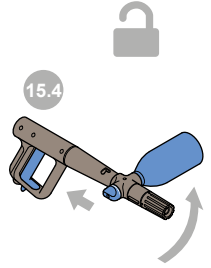

15.5

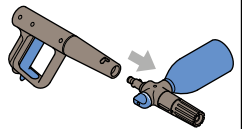

16

MIN



MAX

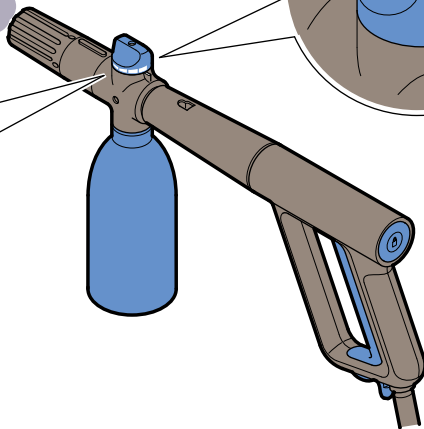
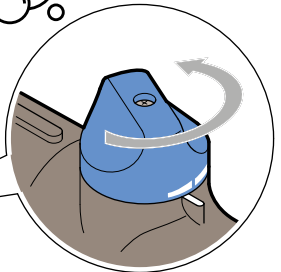
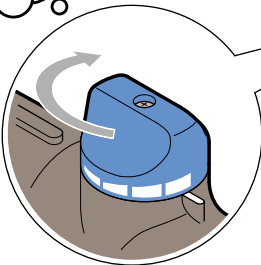

C

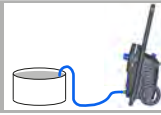

1

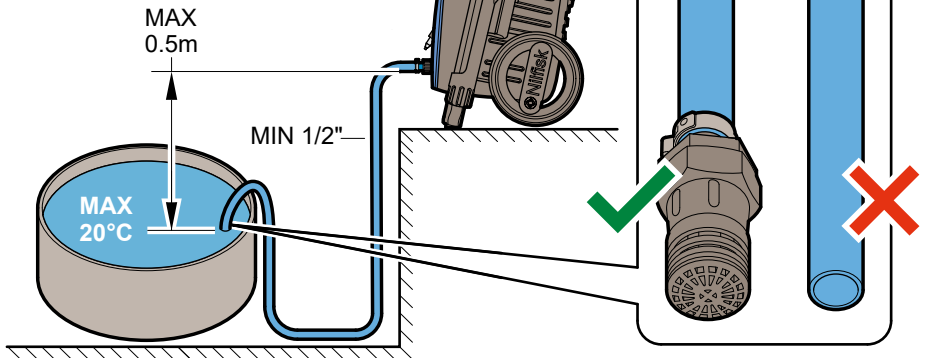
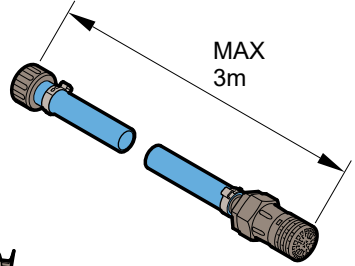
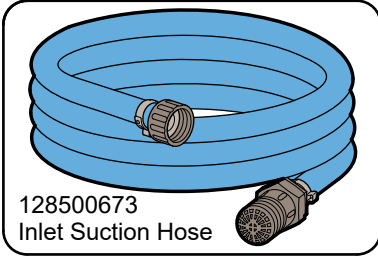

2

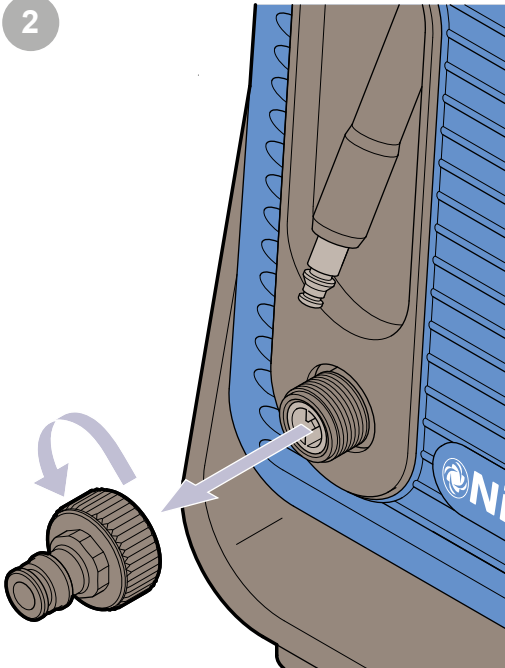

3

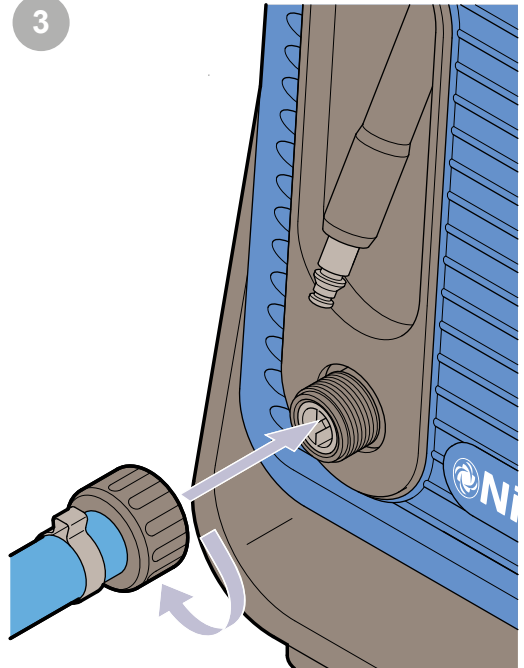

C

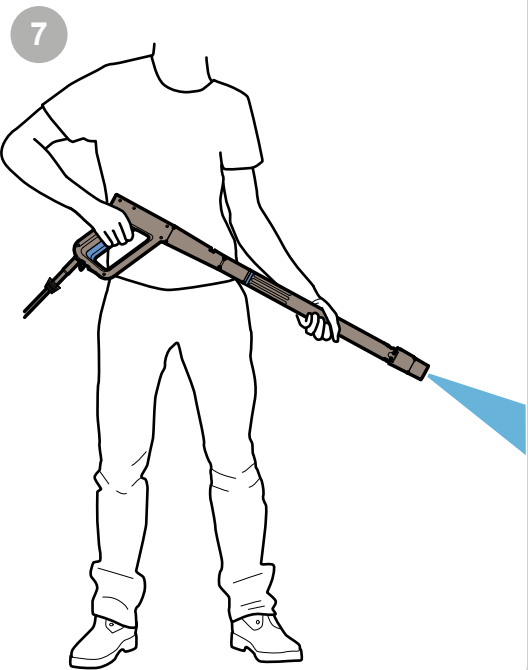
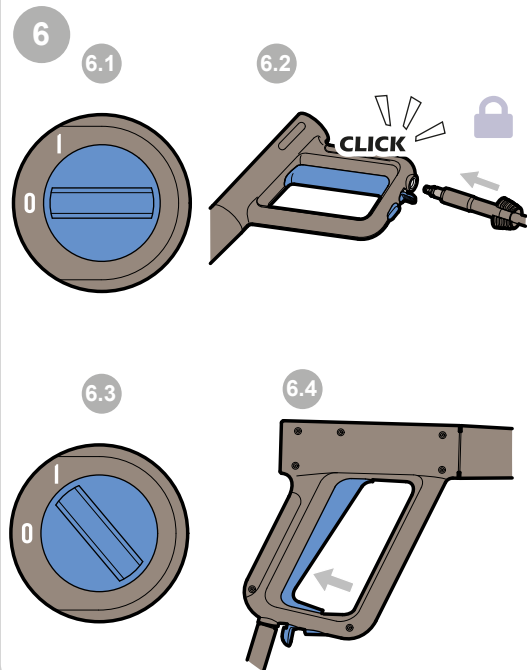
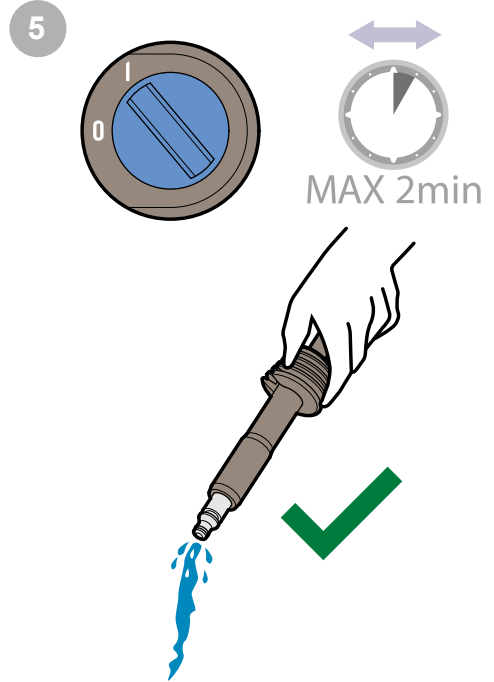
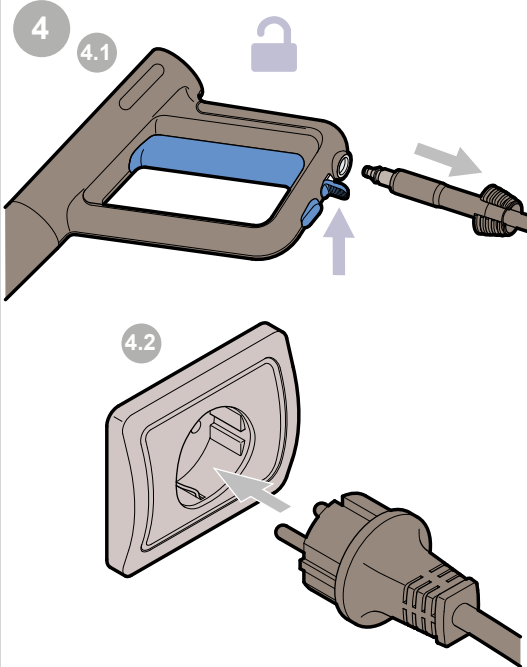
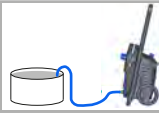

D

⏸ >5min



1

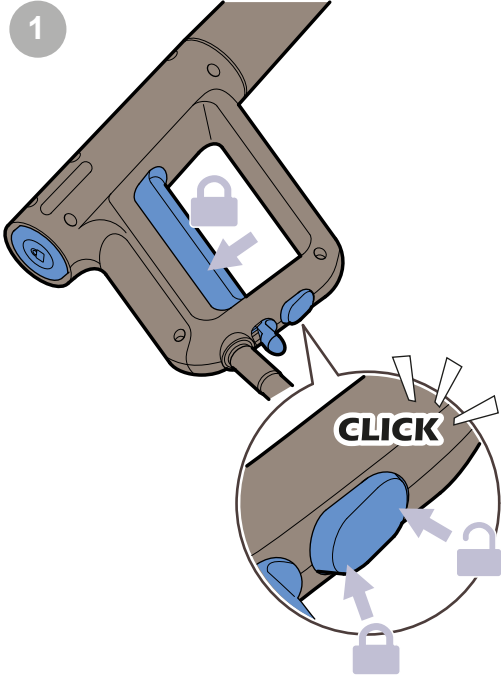

2

2.1

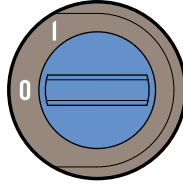

2.2

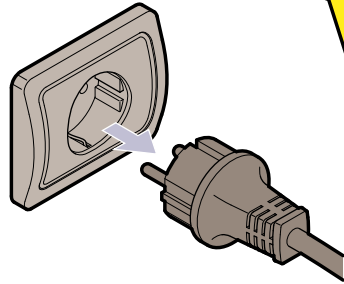

2.3

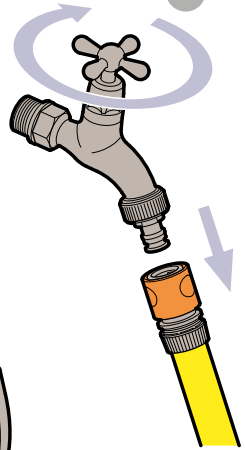

Cet appareil se recycle



À déposer EN MAGASIN

À déposer EN DÉCHÈTERIE

Points de collecte sur [www.quefairedemesdechets.fr](http://www.quefairedemesdechets.fr)  
Privilégiez la réparation ou le don de votre appareil !

E

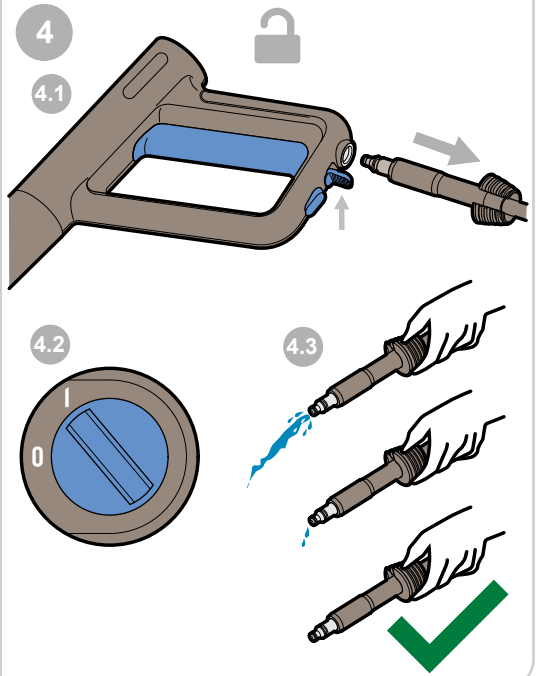
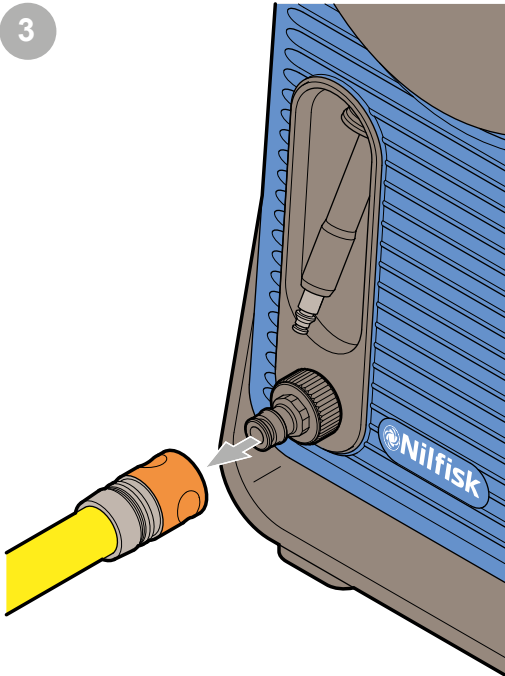
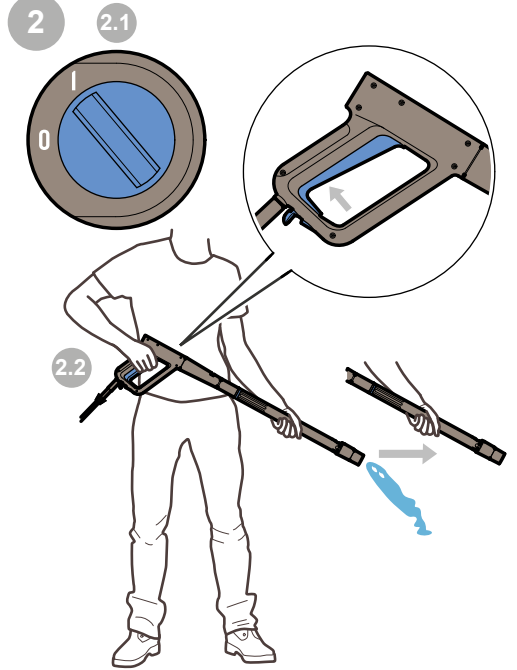
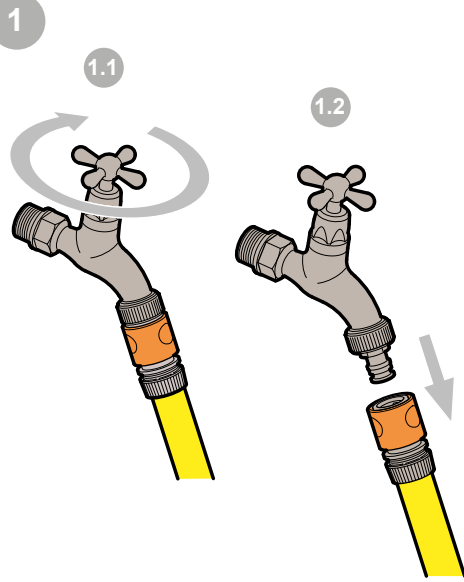
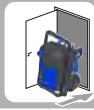



E



5

5.1

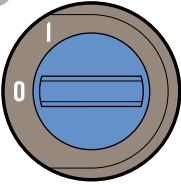

5.2

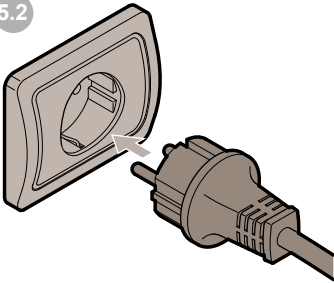

6

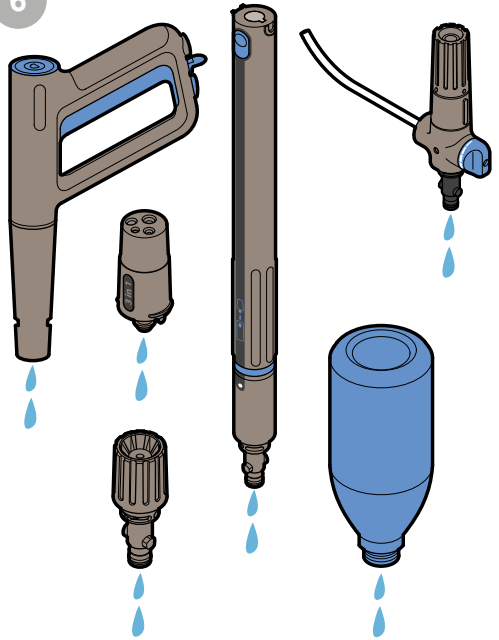

7

7.1

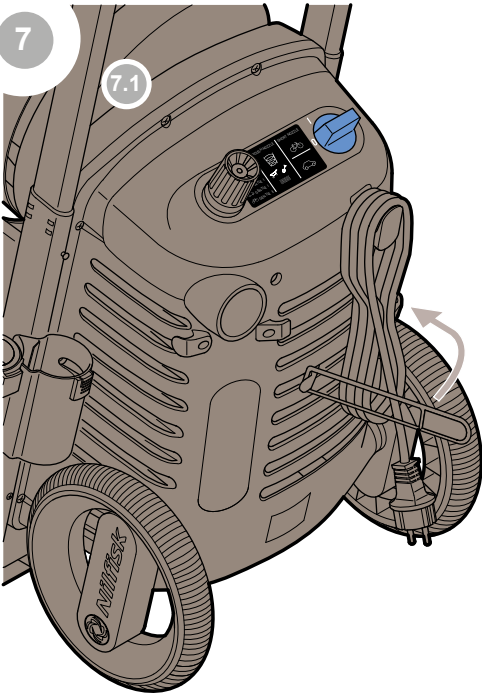

7.2

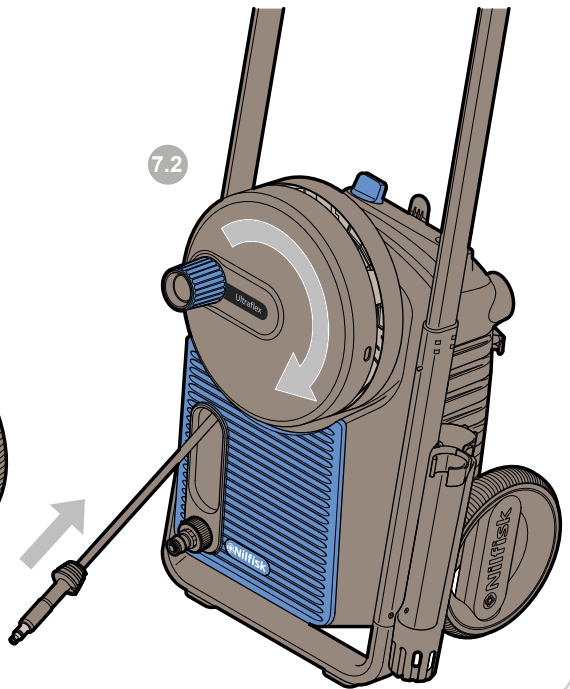

E



8

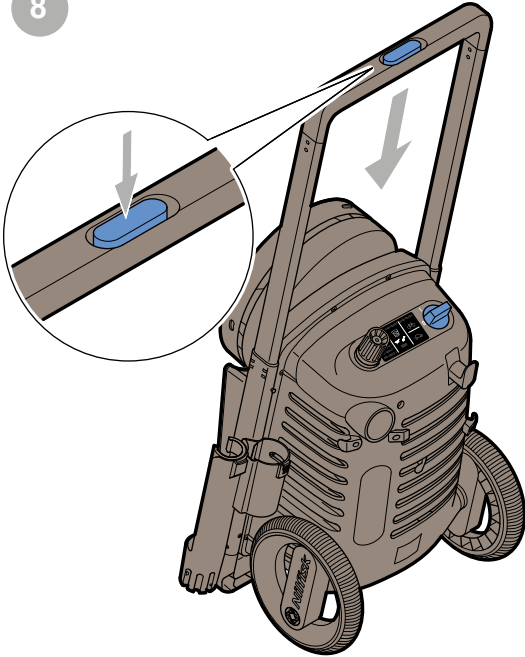

9

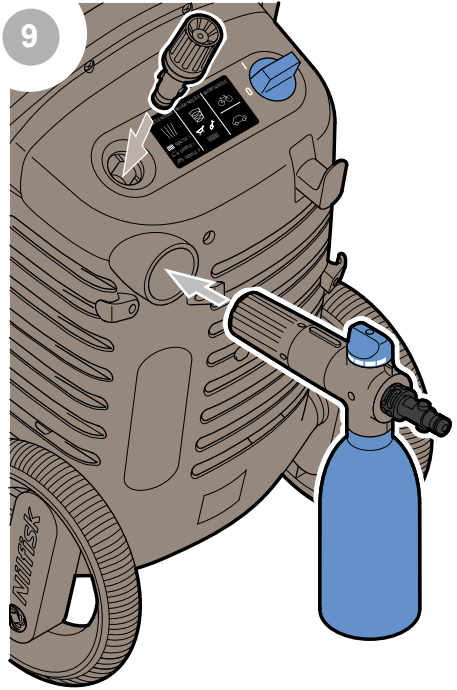

10

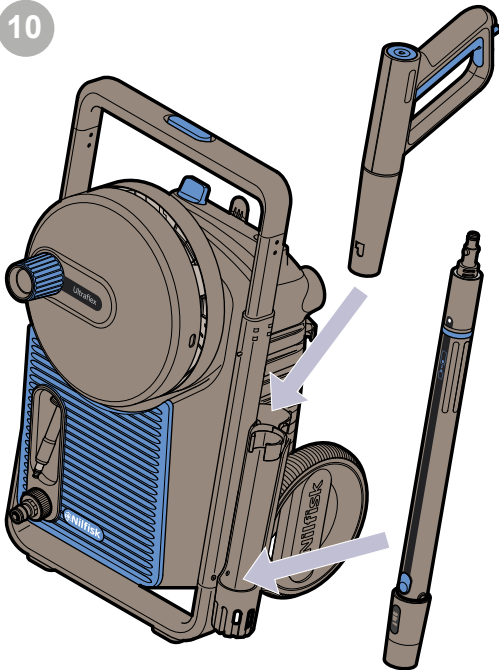

11

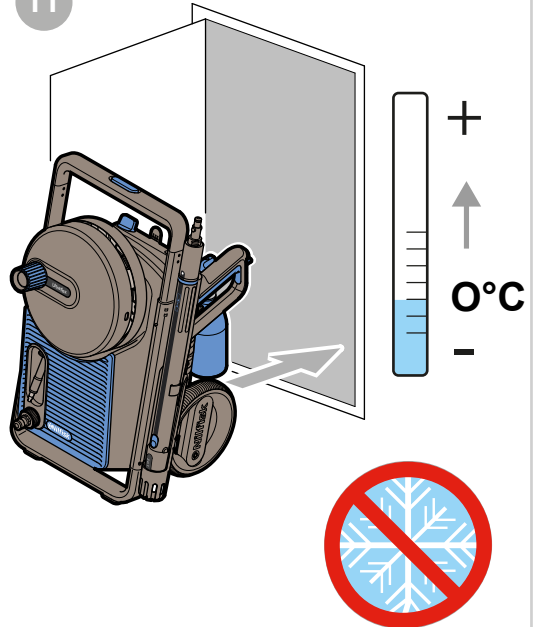



1

1.1

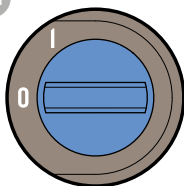

1.2

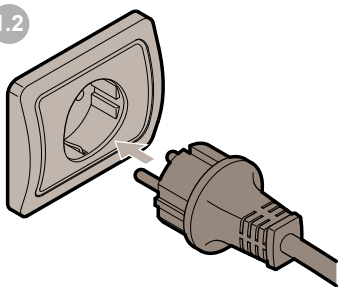

2

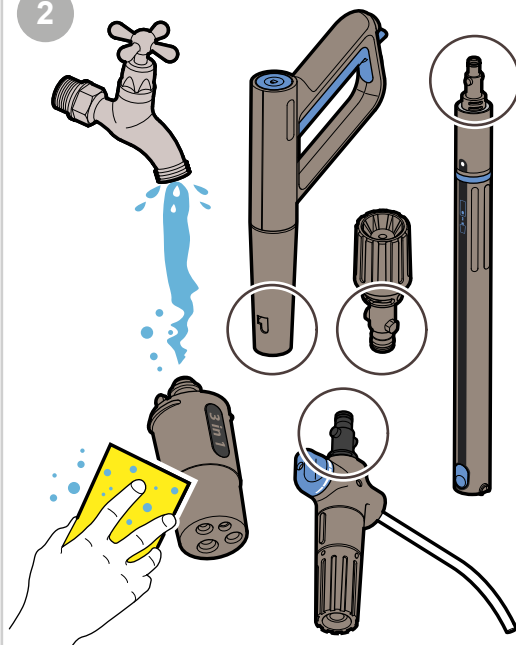

3

3.1

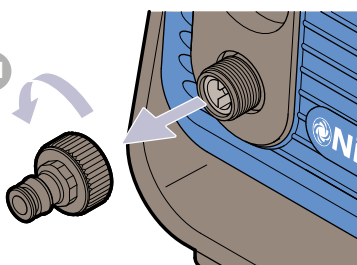

3.2

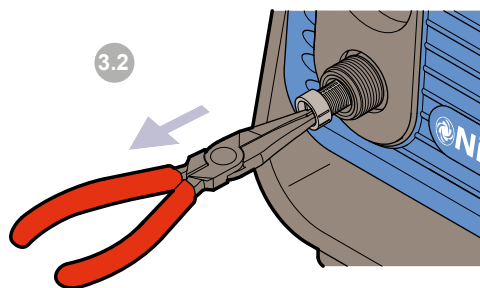

4

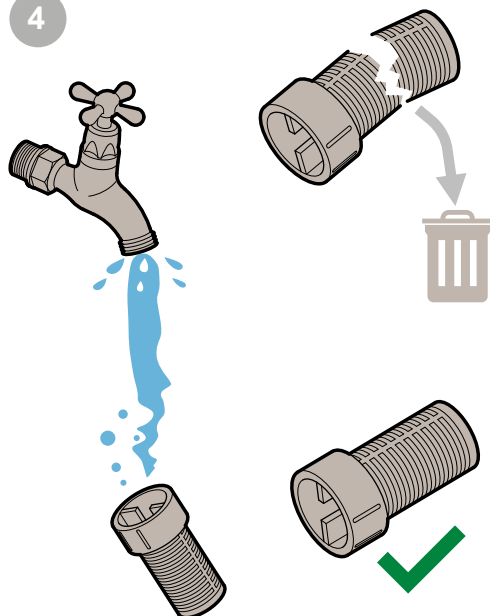

F



5

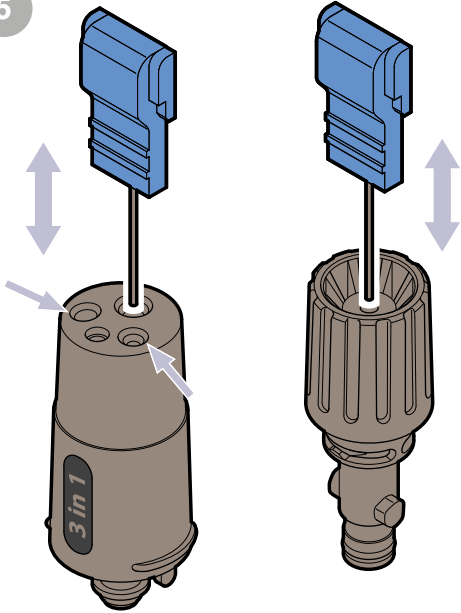

6

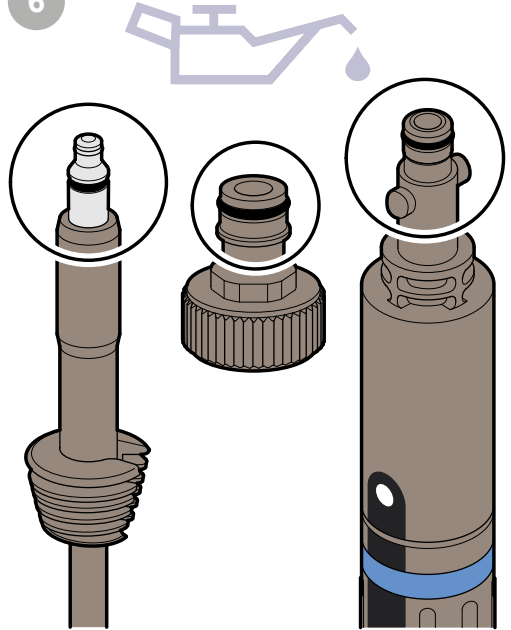

7

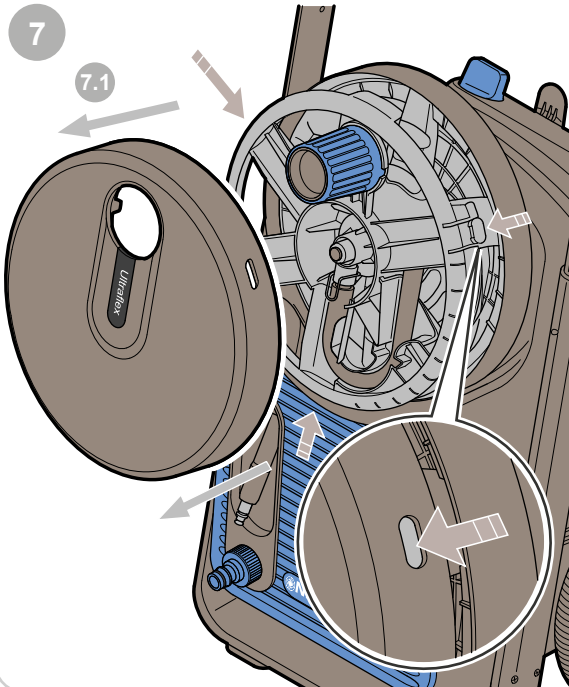

7.2

